



# 設置マニュアル

Club 34F

Club 44F

Club 54F

Club 64FSL

Club 644F

Club 864F

Club 964M

Club 64

Club 64SQ

Club 194T

Club 64CSQ

Club 64C

Club 64CTP

# Club 34F

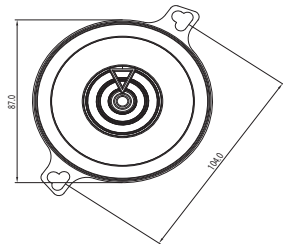
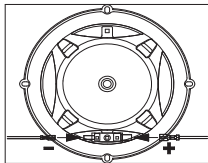
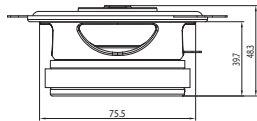

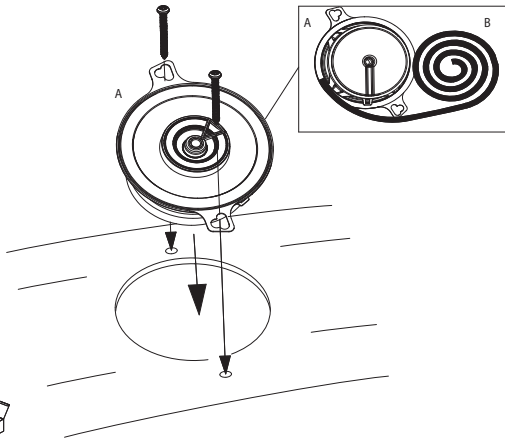
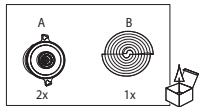

## 仕様書

- 型: 3-1/2インチ (87mm) 2ウェイ・カー  
スピーカー
- 許容入力: 25W RMS、75Wピーク
- 出力音圧レベル (2.83V/m) : 89dB
- 周波数特性: 90Hz~20kHz
- 公称インピーダンス: 3.0Ω

## T/S パラメータ

- BL (Tm): 2.873
- DCR (ohms): 2.26
- Mms (g): 3.723
- Sd (cm<sup>2</sup>): 44.18
- Cms (μm/N): 0.491
- Vas (l): 1.3574
- Fs (Hz): 117.7
- Qes: 0.755
- Qms: 7.777
- Qts: 0.688
- Crossover Point: 4kHz

# Club 44F

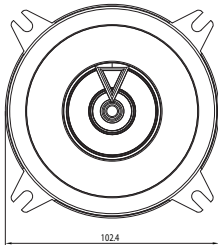
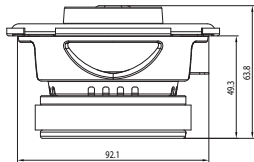
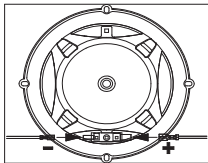

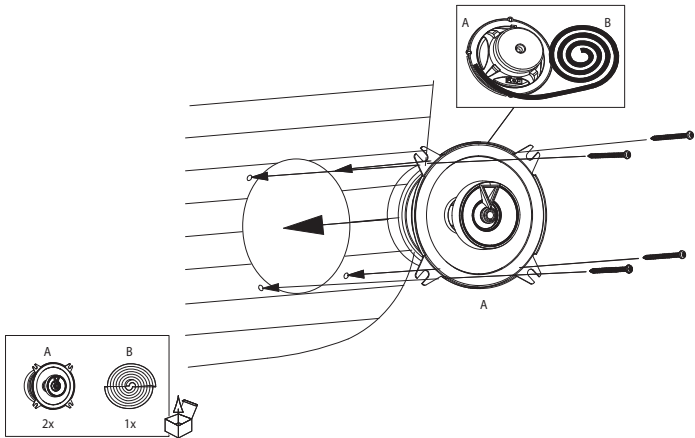

## 仕様書

- 型:4インチ(100mm)2ウェイ・カースピーカー
- 許容入力:35W RMS、105Wピーク
- 出力音圧レベル(@2.83V):90dB
- 周波数特性:75Hz~20kHz
- 公称インピーダンス:3.0Ω

## T/S パラメータ

- BL (Tm): 3.783
- DCR (ohms): 2.46
- Mms (g): 6.608
- Sd (cm<sup>2</sup>): 63.62
- Cms (μm/N): 0.750
- Vas (l): 4.2937
- Fs (Hz): 71.5
- Qes: 0.510
- Qms: 6.495
- Qts: 0.473
- Crossover Point: 3kHz

# Club 54F

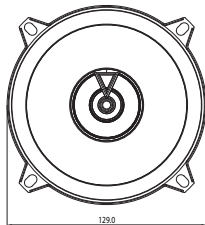
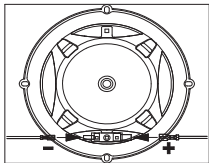
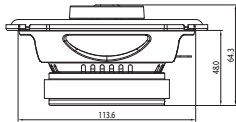



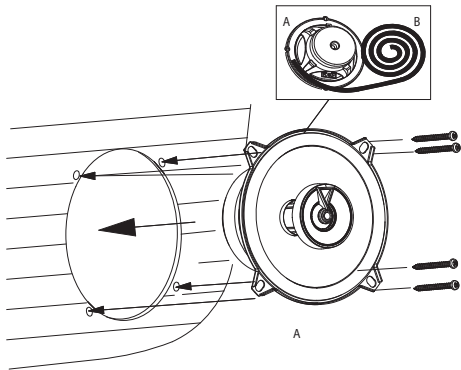
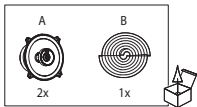

## 仕様書

- 型:5-1/4インチ(130mm)2ウェイ・カー  
ースピーカー
- 許容入力:45W RMS、135Wピーク
- 出力音圧レベル(@2.83V):91dB
- 周波数特性:75Hz~20kHz
- 公称インピーダンス:3.0Ω

## T/S パラメータ

- BL (Tm): 3.563
- DCR (ohms): 2.24
- Mms (g): 9.484
- Sd (cm<sup>2</sup>): 103.87
- Cms (μm/N): 0.274
- Vas (l): 4.1850
- Fs (Hz): 98.7
- Qes: 1.036
- Qms: 8.608
- Qts: 0.925
- Crossover Point: 3kHz

# Club 64FSL

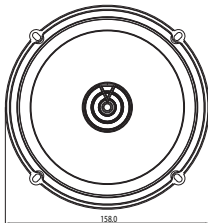
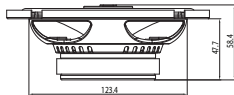
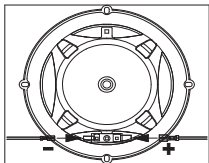

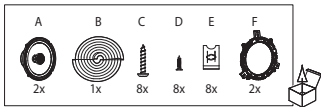
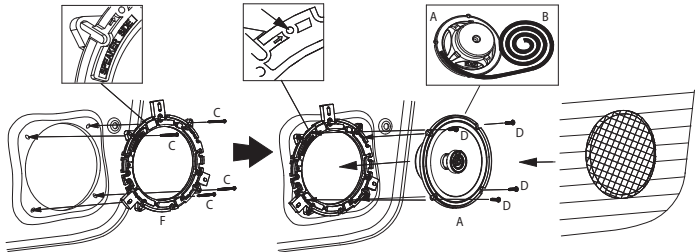

## 仕様書

- 型: Shallow-Mount 6-1/2インチ (160mm) 2ウェイ・カーブスピーカー
- 許容入力: 55W RMS、165Wピーク
- 出力音圧レベル (@2.83V) : 92dB
- 周波数特性: 55Hz~20kHz
- 公称インピーダンス: 3.0Ω

## T/S パラメータ

- BL (Tm): 3.739
- DCR (ohms): 2.41
- Mms (g): 9.934
- Sd (cm<sup>2</sup>): 122.72
- Cms (μm/N): 0.278
- Vas (l): 5.9287
- Fs (Hz): 95.7
- Qes: 1.032
- Qms: 11.357
- Qts: 0.946
- Crossover Point: 4kHz

# Club 644F

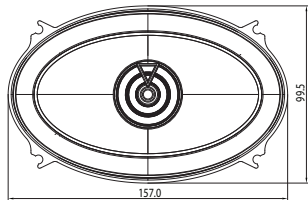
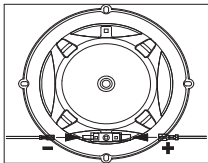
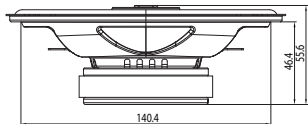

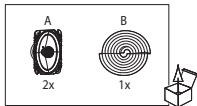
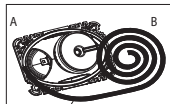
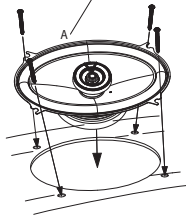
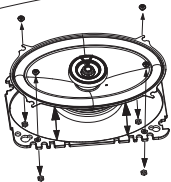
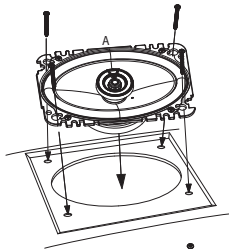

## 仕様書

- 型:4x6インチ (100mmx152mm) 2ウェイ・カースピーカー
- 許容入力:40W RMS、120Wピーク
- 出力音圧レベル (@2.83V) :92dB
- 周波数特性:75Hz~20kHz
- 公称インピーダンス:3.0Ω

## T/S パラメータ

- BL (Tm): 3.296
- DCR (ohms): 2.5
- Mms (g): 7.86
- Sd (cm<sup>2</sup>): 86.59
- Cms (μm/N): 0.245
- Vas (l): 2.5977
- Fs (Hz): 114.7
- Qes: 1.303
- Qms: 12.752
- Qts: 1.182
- Crossover Point: 3kHz



# Club 864F

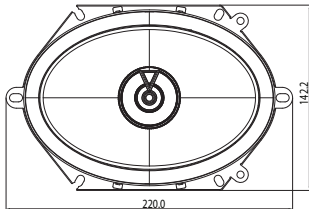
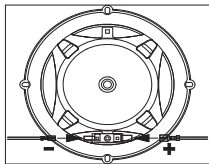
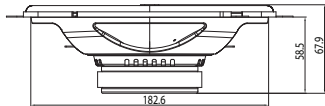

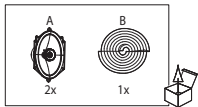
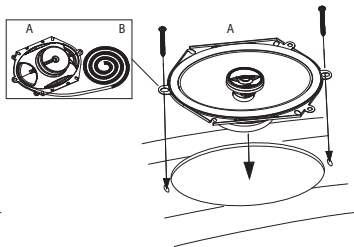
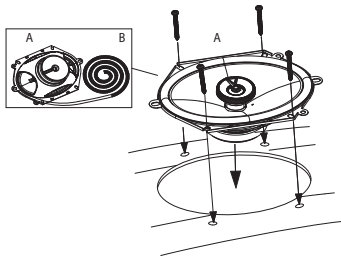

## 仕様書

- 型:6x8インチ (152mmx203mm) 2ウェイ・カースピーカー、グリルなし
- 許容入力:60W RMS、180Wピーク
- 出力音圧レベル (@2.83V) :93dB
- 周波数特性:65Hz~20kHz
- 公称インピーダンス:3.0Ω

## T/S パラメータ

- BL (Tm): 3.785
- DCR (ohms): 2.39
- Mms (g): 17.718
- Sd (cm<sup>2</sup>): 165.13
- Cms (μm/N): 0.336
- Vas (l): 12.9798
- Fs (Hz): 65.2
- Qes: 1.210
- Qms: 14.592
- Qts: 1.118
- Crossover Point: 3.5kHz

# Club 964M

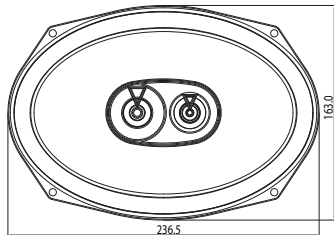
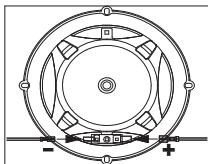
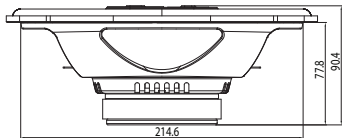

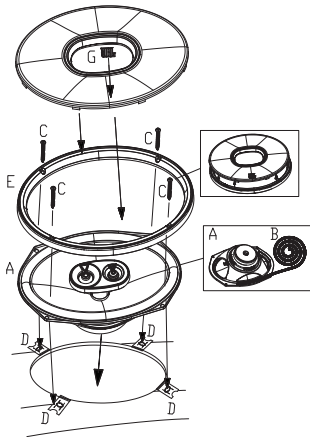
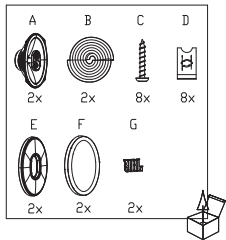

## 仕様書

- 型: 6x9インチ (152mmx230mm) 3ウェイ・カースピーカー
- 許容入力: 85W RMS、255Wピーク
- 出力音圧レベル (@2.83V) : 93dB
- 周波数特性: 50Hz~20kHz
- 公称インピーダンス: 3.0Ω

## T/S パラメータ

- BL (Tm): 4.063
- DCR (ohms): 2.63
- Mms (g): 23.163
- Sd (cm<sup>2</sup>): 226.98
- Cms (μm/N): 0.337
- Vas (l): 24.5866
- Fs (Hz): 56.9
- Qes: 1.321
- Qms: 11.751
- Qts: 1.188
- Crossover Point: 3kHz

# Club 64

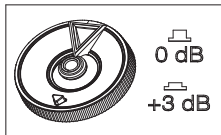
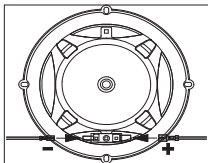

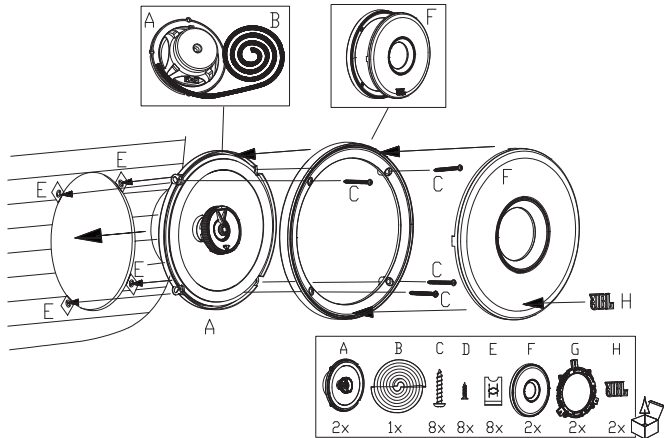



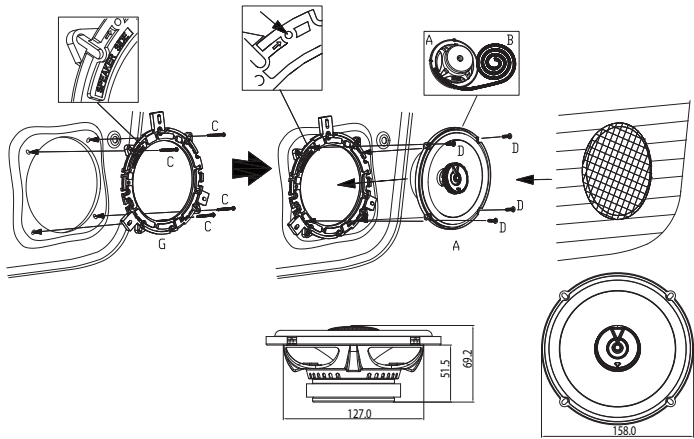

## 仕様書

- 型:より優れたサウンド・パフォーマンスのために設計された、6-1/2インチ (160mm) 2ウェイ・カースピーカー。
- 許容入力:60W RMS、180Wピーク
- 出力音圧レベル (@2.83V) :93dB
- 周波数特性:48Hz~21kHz
- 公称インピーダンス:3.0Ω

## T/S パラメータ

- BL (Tm): 3.632
- DCR (ohms): 2.36
- Mms (g): 13.758
- Sd (cm<sup>2</sup>): 132.73
- Cms (μm/N): 0.378
- Vas (l): 9.4253
- Fs (Hz): 69.8
- Qes: 1.080
- Qms: 10.655
- Qts: 0.980
- Crossover Point: 3.5kHz

# Club 64SQ

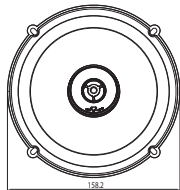
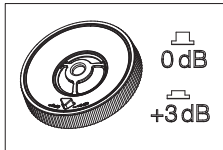
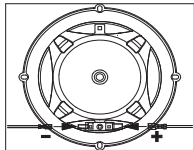
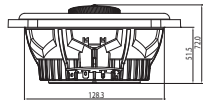

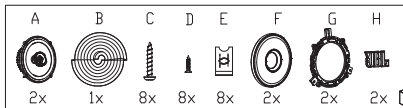
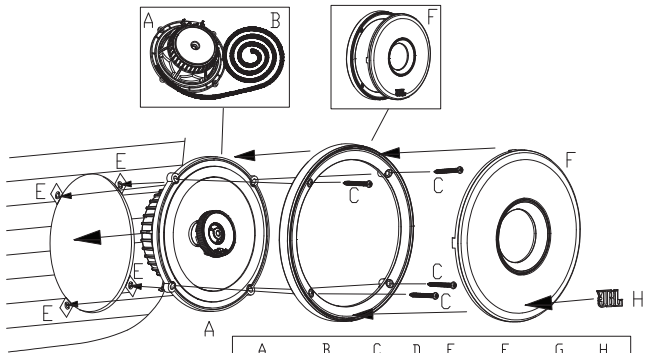

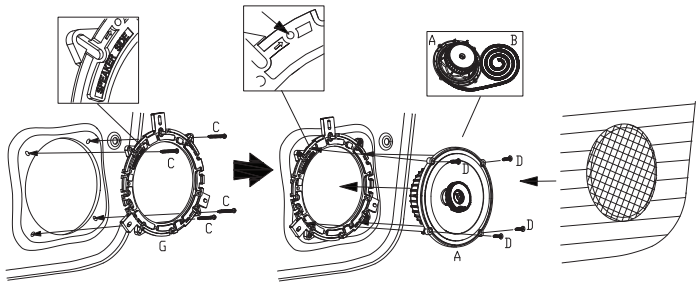

## 仕様書

- 型:究極の音質に設計された6.5インチ(160mm) 2ウェイスピーカー
- 許容入力:75W RMS、225Wピーク
- 出力音圧レベル(@2.83V):93dB
- 周波数特性:48Hz~21kHz
- 公称インピーダンス:3.0Ω

## T/S パラメータ

- BL (Tm): 3.748
- DCR (ohms): 2.12
- Mms (g): 12.273
- Sd (cm<sup>2</sup>): 132.73
- Cms (μm/N): 0.530
- Vas (l): 13.2162
- Fs (Hz): 62.4
- Qes: 0.724
- Qms: 9.037
- Qts: 0.671
- Crossover Point: 5 kHz

# Club 194T

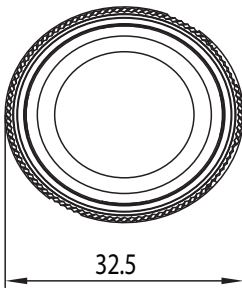
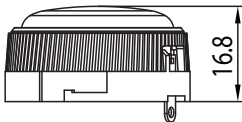

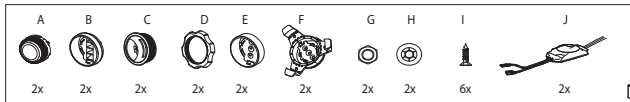
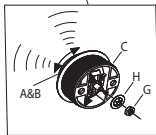
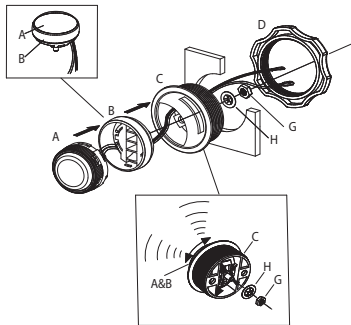
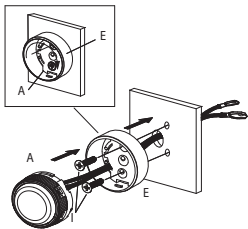



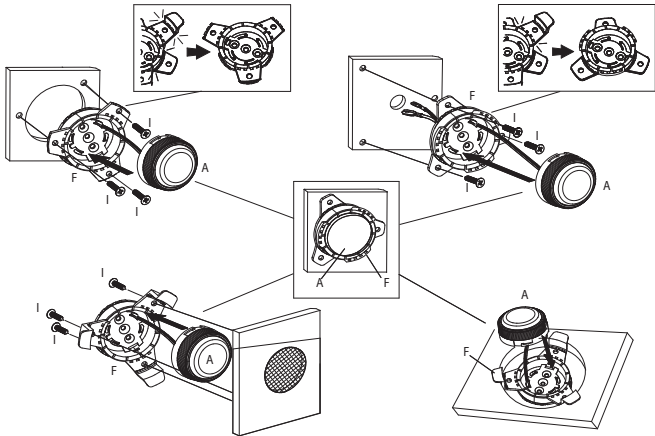

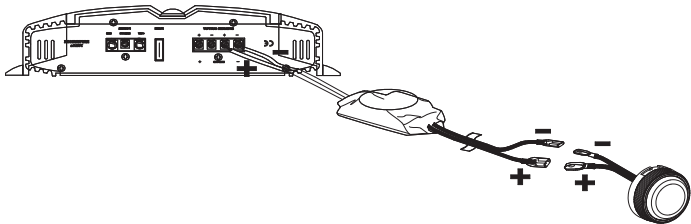

## 仕様書

- 型:3/4インチ(19mm) エッジ駆動ドームツイーター
- 許容入力:50W RMS、150Wピーク
- 出力音圧レベル(@2.83V):92dB
- 周波数特性:3kHz~20kHz
- 公称インピーダンス:3.0Ω

# Club 64CSQ

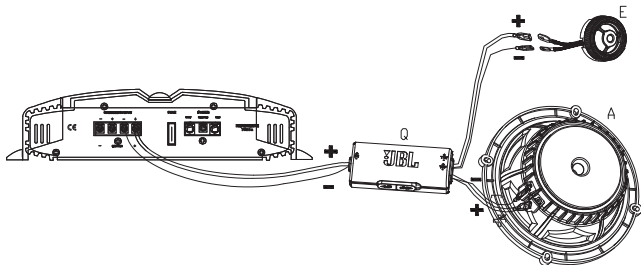
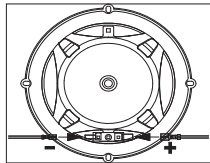

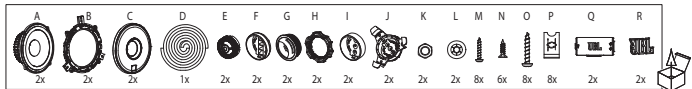
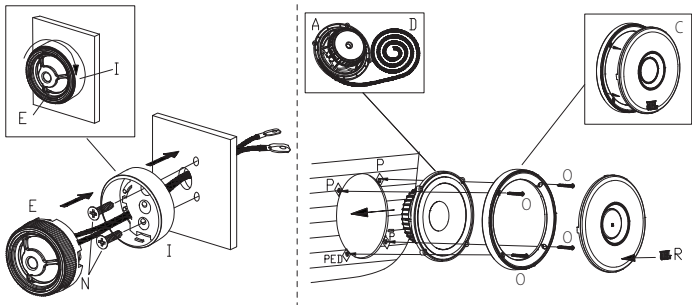

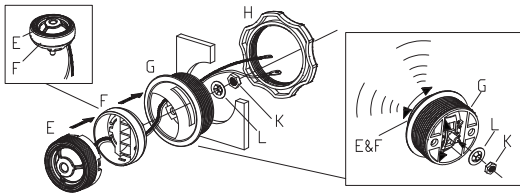
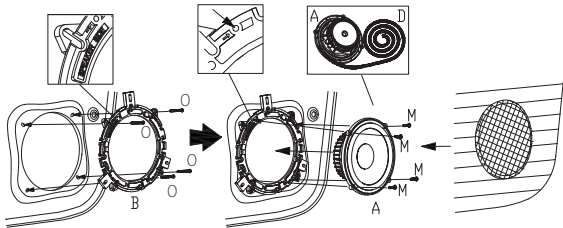

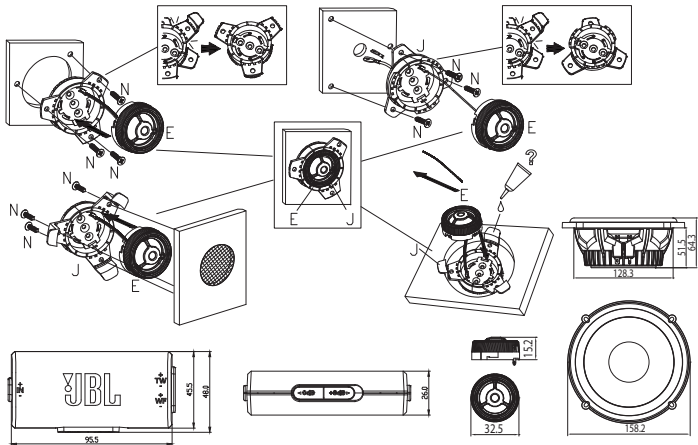

## 仕様書

- 型:究極の音質に設計された6.5インチ(160mm) セパレートスピーカー
- 許容入力:95W RMS、285Wピーク
- 出力音圧レベル(@2.83V):93dB
- 周波数特性:48Hz~21kHz
- 公称インピーダンス:3.0Ω

## T/S パラメータ

- BL (Tm): 3.776
- DCR (ohms): 2.09
- Mms (g): 13.238
- Sd (cm<sup>2</sup>): 132.73
- Cms (μm/N): 0.536
- Vas (l): 13.3648
- Fs (Hz): 59.7
- Qes: 0.728
- Qms: 8.315
- Qts: 0.670
- Crossover Point: 5 kHz



# Club 64C

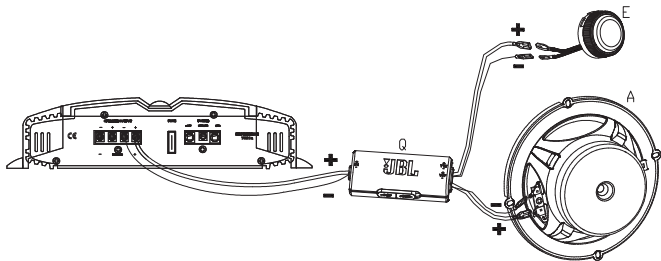
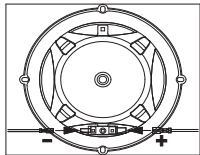

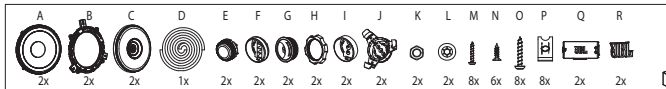
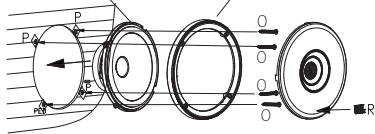
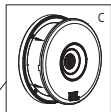
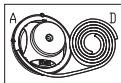
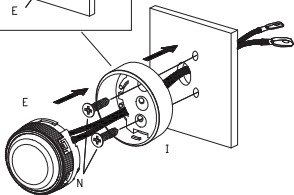
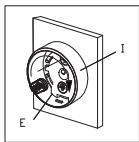

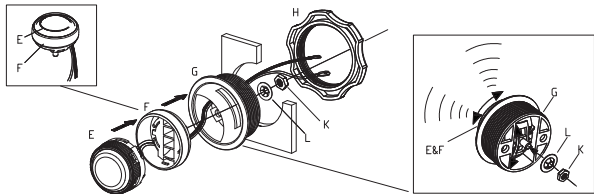
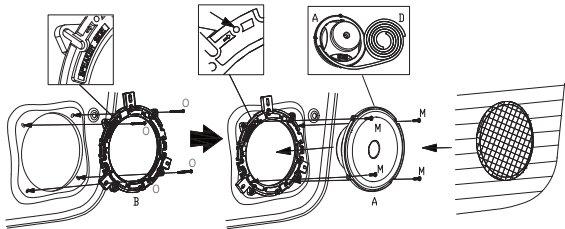

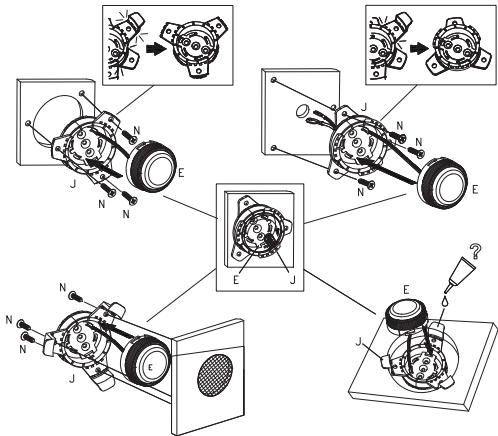

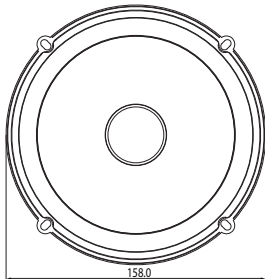
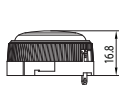
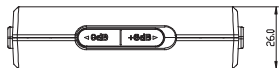
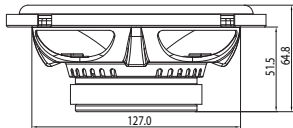
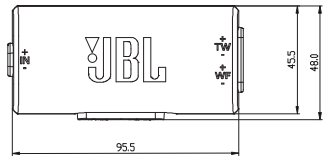

## 仕様書

- 型:6-1/2インチ(160mm)2ウェイ・コンポーネント・スピーカーシステム
- 許容入力:70W RMS、210Wピーク
- 出力音圧レベル(@2.83V):92dB
- 周波数特性:55Hz~20kHz
- 公称インピーダンス:3.0Ω

## T/S パラメータ

- BL (Tm): 3.635
- DCR (ohms): 2.37
- Mms (g): 14.409
- Sd (cm<sup>2</sup>): 132.73
- Cms (μm/N): 0.257
- Vas (l): 6.4107
- Fs (Hz): 82.7
- Qes: 1.340
- Qms: 10.965
- Qts: 1.194
- Crossover Point: 5.5kHz

# Club 64CTP

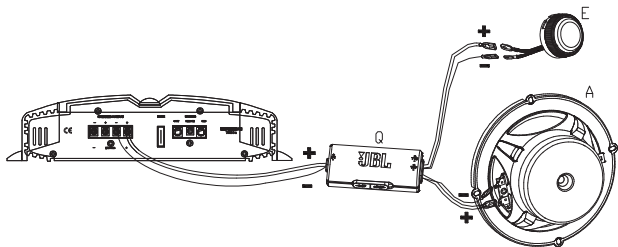
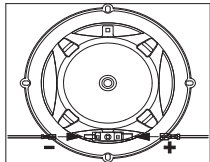

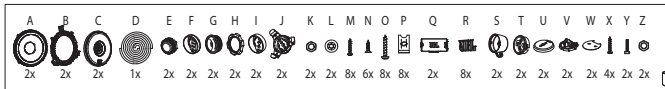
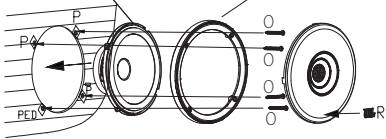
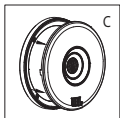
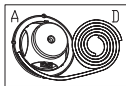
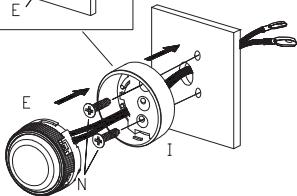
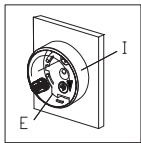



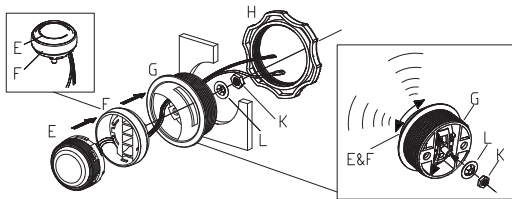
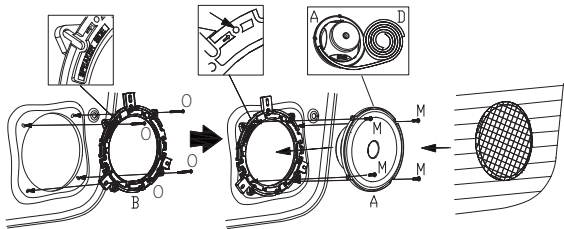

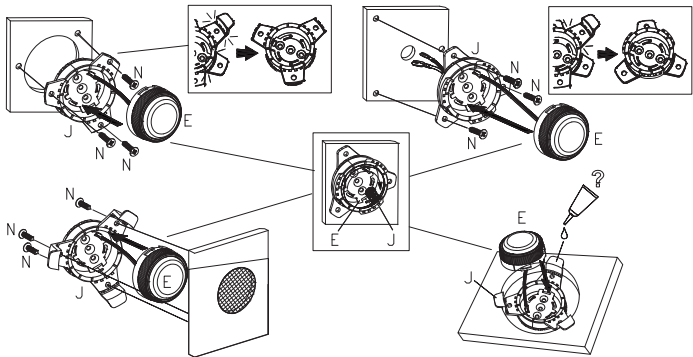

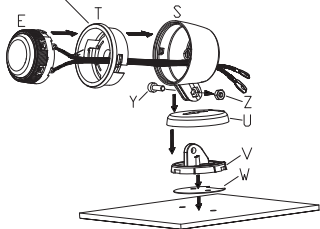
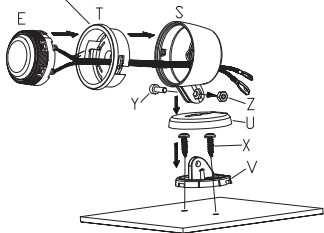

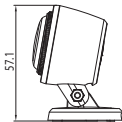
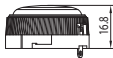
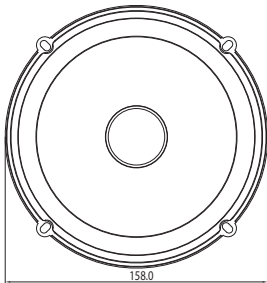
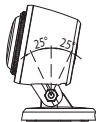
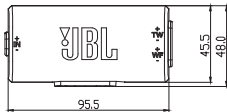
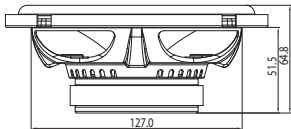

## 仕様書

- 型: ツイーターポッド付き、6-1/2インチ (160mm) 2ウェイ・コンポーネント・スピーカーシステム
- 許容入力: 70W RMS、210Wピーク
- 出力音圧レベル (@2.83V) : 92dB
- 周波数特性: 55Hz~20kHz
- 公称インピーダンス: 3.0Ω

## T/S パラメータ

- BL (Tm): 3.635
- DCR (ohms): 2.37
- Mms (g): 14.409
- Sd (cm<sup>2</sup>): 132.73
- Cms (μm/N): 0.257
- Vas (l): 6.4107
- Fs (Hz): 82.7
- Qes: 1.340
- Qms: 10.965
- Qts: 1.194
- Crossover Point: 5.5kHz



HARMAN International Industries,  
Incorporated  
8500 Balboa Boulevard, Northridge,  
CA 91329 USA

© 2023 HARMAN International  
Industries, Incorporated.

All rights reserved.

JBLは、HARMAN International Industries, Incorporatedの商標であり、  
米国およびその他の国々で登録されています。  
機能、仕様および外観は、予告なく変更されることがあります。